

PRINCIPAL TECHNICAL CHARACTERISTICS CARACTERISTIQUES TECHNIQUES PRINCIPALES



- **3 possible versions**
 - Single indicator
 - Momentary action pushbutton (1 stable position)
 - Alternate action pushbutton (2 stable positions)
- 3 versions possibles
- Indicateur simple
 - Bouton poussoir à action momentanée (1 position stable)
 - Bouton poussoir à action alternée (2 positions stables)

- **Up to 4 field split display**
Possibilité de 1 à 4 secteurs de couleur et de gravure différente

- **4 PDT output contacts**
4 Contacts

- **Engraving / Optical technology**
 1. Classical
 2. Sunlight readable
 3. « NVG » compatible

Technologie Optique / Gravure

1. Classique
2. Lisible « plein soleil »
3. Compatible « NVG »

- **Applicable standard : MIL-S-22885**
Norme de référence : MIL-S-22885

- **Special models available upon request**
Modèles spécifiques sur demande

MECHANICAL CHARACTERISTICS CARACTERISTIQUES MECANIQUE

Weight standard unit with mounting sleeve, without connector <i>Masse standard avec boîtier de fixation, sans connecteur</i>	26 ± 0.8 grams
Weight standard unit with mounting sleeve and connector <i>Masse standard avec boîtier de fixation et avec connecteur</i>	38 ± 1.5 grams
Mechanical life <i>Durée de vie mécanique</i>	>100 000 cycles
Protrusion of head <i>Protusion de tête</i>	E1: 3 ± 0.5 mm E2: 7 ± 0.5 mm
Actuation force <i>Force d'appui</i>	10N ± 2.5N
Actuation force with option sealing of cap <i>Force d'appui avec l'option tête étanche</i>	13.5N ± 2.5N
Applicable force to release the button <i>Force applicable au relâchement du bouton</i>	3.5N ± 1.5N
Applicable force to release the button (J2 option) <i>Force applicable au relâchement du bouton (option J2)</i>	4N ± 1.5N
Push button travel (head in ON position / initial position) <i>Course bouton poussoir (tête en position ON / position initial)</i>	0.65 ± 0.25mm
Full travel <i>Course jusqu'en butée</i>	2.6 ± 0.25mm
Head retention (from its body) <i>Effort de rétention tête</i>	14N ± 2N
Mounting panel thickness <i>Epaisseur du panneau de montage</i>	19 mm max.
Applicable torque on fixing screws <i>Couple de serrage des vis de fixation</i>	0.10 Nm
Maximal applicable force (without damage) <i>Force maximale applicable (sans dommage)</i>	50 N

LEACH INTERNATIONAL EUROPE S.A.S.
Tel: +33 3 87 97 98 97
Fax: +33 3 87 97 96 86

LEACH INTERNATIONAL ASIA PACIFIC
Tel: +852 2 191 3830
Fax: +852 2 389 5803

The technical information provided by Leach International Europe is to be used as a guide only, and is not meant for publication or as documentation for altering any existing specification. Dimensions are in millimeters unless otherwise specified. Rev. 06/2019.

ELECTRICAL CHARACTERISTICS CARACTERISTIQUES ELECTRIQUE

Contact bounce for individual switches <i>Temps de rebond pour un switch synchronisé entre les 4 pôles</i>	< 2.5 ms
Time between 4 poles / Temps entre 4 pôles	<5 ms
Dielectric strength / Rigidité diélectrique	< 0.5 mA (1000 Vrms / 50 Hz)
Insulation resistance / Résistance d'isolement	>1000 MΩ (500Vdc)
Initial contact resistance at nominal current <i>Résistance du contact initiale au courant nominal</i>	<25 mΩ
Electrical life at full load / Durée de vie électrique à pleine charge	>50 000 cycles
Normal surge voltage / Surtension normal	According to MIL-RTCA DO 160E section 16
Anormal surge voltage / Surtension anormal	According to MIL-RTCA DO 160E section 16
Voltage spike / Pic de tension	According to MIL-RTCA DO 160E section 17, (600Vdc/10μs)

ELECTRICAL SWITCH RATING POUVOIR DE COUPURE

Contact material B1	
28 Vdc rating (see level) -Inductive -Resistive -Lamp	4 A 7 A 2.5 A
28 Vdc rating (50 000FT) -Inductive -Resistive -Lamp	2.5 A 4 A 2.5 A
115V AC rating (see level) -Inductive -Resistive -Lamp	7 A 7 A 2 A
Contact material B2 or J7	
28 Vdc rating (see level) -Inductive -Resistive	500 mA 1 A
28 Vdc rating (50 000FT) -Inductive -Resistive	500 mA 1 A

LED CIRCUIT DETAIL CIRCUIT LED

Dielectric strength/ Rigidité diélectrique	0.5 mA (1000Vrms / 50Hz)
Insulation resistance at 500 Vdc/ Résistance d'isolement sous 500 Vcc	> 1000 M Ω

LED offer optical performance in luminance and colour. They improve legend uniformity. L404 has very long operating time. They allow lower power consumption and lower surface temperature than incandescent lamp can do.

Les LED offrent des performances en luminescence et en couleur. Ils améliorent l'uniformité de la légende. L404 à une très longue durée de fonctionnement. Ils permettent de réduire la consommation et la température, par rapport à une lampe à incandescence.

LED CIRCUIT SHEMATICS

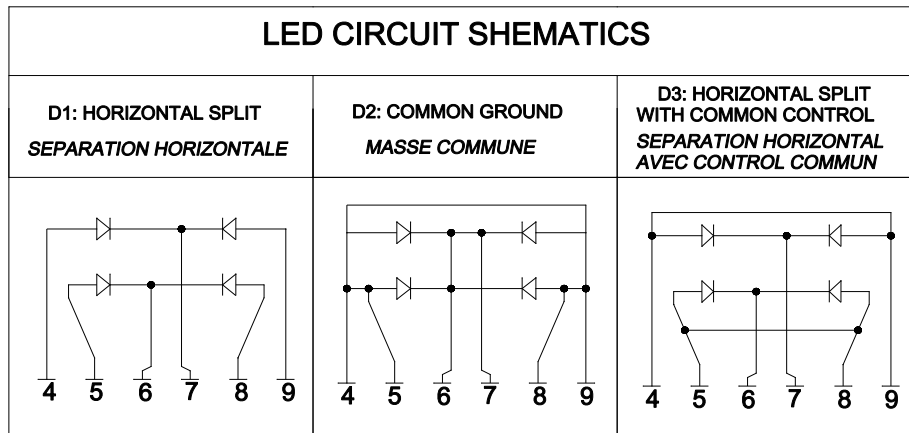

ENVIRONMENTAL DATA CARACTERISTIQUES D'ENVIRONNEMENT

Operating temperature/ Température d'utilisation	-55 C à +85 C according to RTCA-DO 160E section 4 and 5
Terminal shock / Choc terminal	According to MIL-PRF-22885-G
Vibration / Vibrations [1]	15g 10-2000 Hz according to MIL-PRF-22885-G
Acceleration / Accélération [1]	20g according to MIL-PRF-22885-G
Shock / Choc [1]	75g (6ms) according to MIL-PRF-22885-G
Humidity / Humidité relative [1]	RH 95% at +40°C (96 hours) according to MIL-PRF-22885-G
Salt spray / Brouillard salin	According to MIL-PRF-22885-G
Sand and dust / Sable et poussière	According to MIL-PRF-22885-G
Moisture resistance / Résistance à l'humidité	According to MIL-PRF-22885-G
Radio frequency emission / Emission de fréquence radio	Not applicable (passive components)
Radio frequency susceptibility / Fréquence radio susceptible	According to MIL-TTCA DO 160E section 20, category R
Lightning induced transient / Eclaircissement transitoire induit [3]	A2 – G2 Waveform 3 according to RTCA-DO 160E section 22

STANDARD FEATURES AND OPTIONS CONFIGURATION STANDARD ET OPTIONS

A/ Version	B/ Contact material	D/ LED circuit	E/ Head protrusion	J/ Option	
1 : Indicator	1 : 1-7A (high level)	1 : Horizontal split	1 : 3mm	1 : Flip gard	51: Connector with crimp contacts with fixing holes
2 : Momentary	2 : 1A or less (low level)	2 : Common ground	2 : 7mm	2: Sealing of cap	6: Connector with PCB contacts without fixing holes
3 : Alternate	3x: 1xB1+3xB2	3: Horizontal split with common control	3: other on request	3: Alternating longer travel	61: Connector with PCB contacts with fixing holes
	4x: 2xB1+2xB2			4: Mounting spacer	7: Specifics pins without grommet
	5x: 3xB1+1xB2	X: Optional		5: Connector with crimp contacts without fixing holes	71: Specifics pins with grommet

G/ Lens configuration							
G1	G2	G3*	G4	G5*	G6*	G7*	G8
1	1 2	1 2	1 2 3	1 3 2	1 2 3	1 2 3	1 2 4 3

* : Requires installation of pushbutton in rotated position

L304- A3 B2 D2 E1 G8 - See below - J5 J1

H1 I2 F12 - - H1 I2 F12 - - H1 I2 F12 - - H1 I2 F12 -

H-W-C or X/ Legend type and style			
DIN Engschrift 1451 – Height 3,5mm (Standard) (Other legend style or height on request)			
Type	Description	Unlighted	Lighted
H1	Hidden legend	Black background	Colored lighted legend / Black background
H2	Hidden background	Black background	Black legend / Colored lighted background
W1	White legend	White legend / Black background	Colored lighted legend / Black background
W2	White background	Black legend / White background	Black lighted legend / Colored lighted background
C1	Colored legend	Colored legend / Black background	Colored lighted legend / Black background
C2	Colored background	Black legend / Colored background	Black lighted legend / Colored lighted background
X	Other specific legend type on request, contact us for information.		

F/ Supply voltage	
1 : 28V	1 : AC
2: 24V	2: DC
3: 12V	3: PWM
4: 6V	
5: other on request	

I/ Color	
1: Yellow	9: Green B class B
2: Blue	10: Red class B
3: Green	11: Yellow class A
4: Red	12: Yellow class B
5: White	13: White class A
6: Green A class A	14: White class B
7: Green A class B	15: Other on request
8: Green B class A	

DIMENSIONS DIMENSIONS

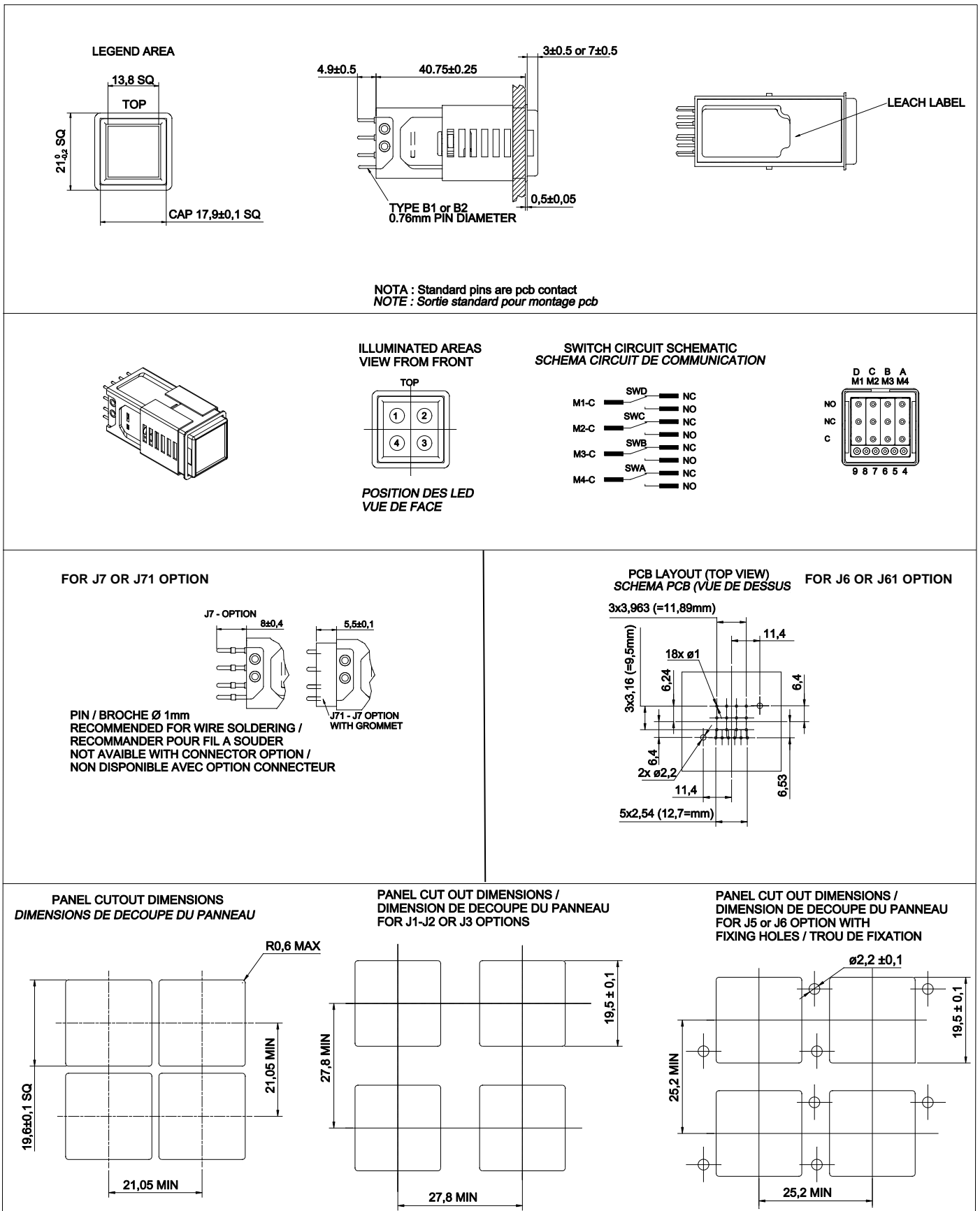

1 – FLIP GUARD
1 – INTERDIT DE RELEVAGE



OPTION : ON REQUEST
SUR DEMANDE

1 – SEALING OF CAP
1 – TETE ETANCHE

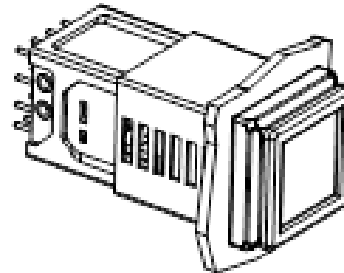

HEAD PROTRUSION FOR THIS OPTION : 6.5mm
PROTRUSION DE TETE POUR CETTE OPTION: 6.5mm

OPTION : ON REQUEST
SUR DEMANDE

3 – LONGER ALTERNATE TRAVEL (1.15mm)
3 – ALTERNE AVEC SURCOURSE (1.15mm)

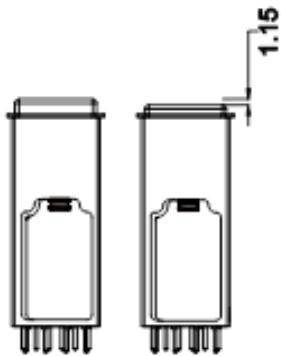

OPTION : ON REQUEST
SUR DEMANDE

4 – MOUNTING SPACER
3 – ENTRETOISE DE TETE

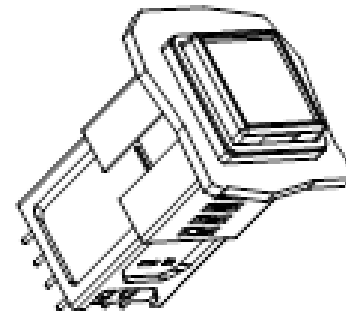

5 – CONNECTOR WITH CRIMP CONTACTS REMOVABLE AWG 20-22-24
(WITH OR WITHOUT FIXING HOLE)
5 – CONNECTEUR AVEC CONTACTS A SERTIR CTS GAUGE 20-22-24
(AVEC OU SANS POINTS DE FIXATION)

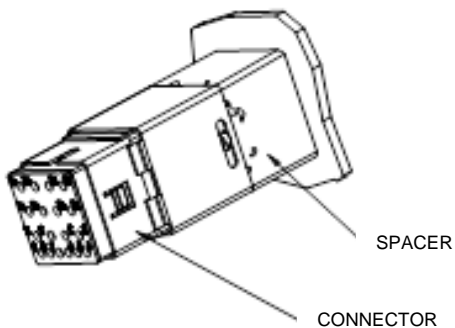

OPTION : ON REQUEST
SUR DEMANDE

6 – CONNECTOR WITH PCB CONTACTS
(WITH OR WITHOUT FIXING HOLE)
5 – CONNECTEUR AVEC CONTACTS A PIQUER SUR PCB
(AVEC OU SANS POINTS DE FIXATION)

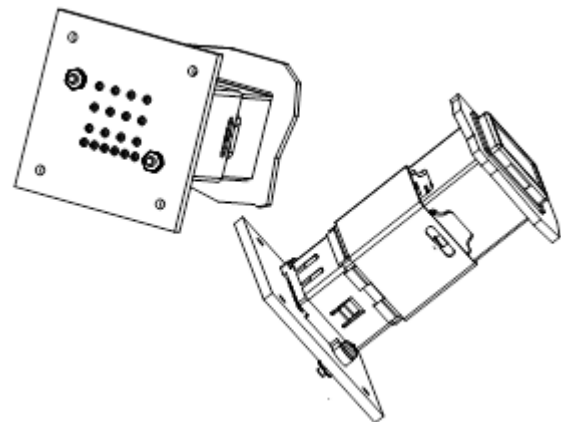

OPTION : ON REQUEST
SUR DEMANDE

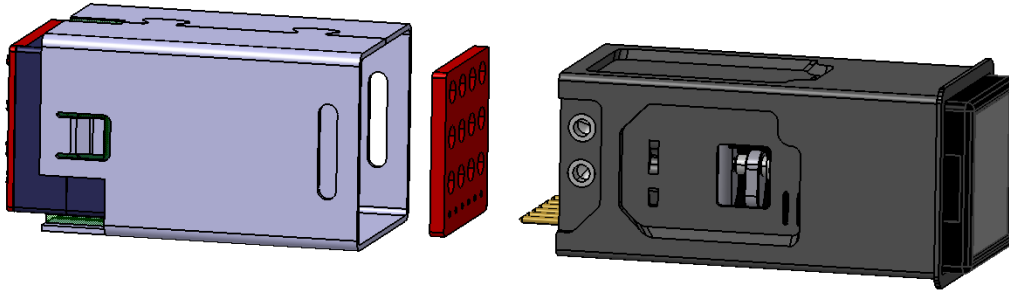

FOR CONNECTORS OPTIONS, SOCKETS ARE DELIVERED WITH A GASKET (THE GASKET MUST BE INSTALLED BETWEEN THE PUSHBUTTON AND THE SOCKET TO ENSURE SEALING OF THE ELECTRICAL CONTACTS).
POUR L'ENSEMBLE DES OPTIONS DE SOCLE LES CONNECTEURS SONT LIVRES AVEC DES UN JOINT INTERFACIAL A MONTER ENTRE LE BOUTON POUSSOIR ET LE SOCLE POUR GARANTIR L'ETANCHEITE DES CONTACTS

**DETAILS FOR J5 - J51 OPTIONS (CRIMP CONTACTS)
DETAILS POUR LES OPTIONS J5 - J51 (CONTACTS A SERTIR)**

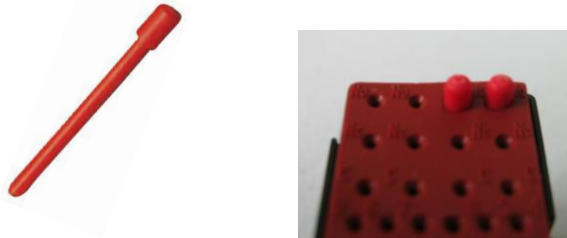

SOCKETS ARE DELIVERED WITH ELECTRICAL CONTACTS NOT INSTALLED. SOCKETS ARE COMPATIBLE WITH #20 MS27488-20-2 OPTURATORS (OBTURATORS NOT SUPPLIED).
LES SOCLES SONT LIVRES AVEC DES CONTACTS NON MONTES. LES SOCLES SONT COMPATIBLES AVEC DES OBTURATEURS DE TAILLE 20 MS27488-20-2 (OBTURATEURS NON FOURNIS)



CONTACT CRIMPING WITH ADJUSTABLE HAND CRIMP TOOL UT6521 AND POSITIONNER UT6526 (POSITIONNER M22520/2-06 AND INCLUDING A SPACER (Ø 1.75±0.02mm – height 1.9 ±0.05mm) FOR CRIMPING THE CONTACTS.
HAND CRIMP TOOL IN POSITION 4 FOR #20, 3 FOR #22, 2 FOR #24
SERTISSAGE DES CONTACTS A L'AIDE DE LA PINCE A SERTIR UT6521 EQUIPEE DE LA TOURELLE UT6526 (TOURELLE M22520/2-06 EQUIPEE D'UNE CALE DE DIAMETRE 1.72+/-0.02mm ET UNE HAUTEUR DE 1.9+/-0.05mm EN FOND DE LA CAVITE
PINCE A SERTIR EN POSITION 4 POUR #20, 3 POUR #22, 2 POUR #24